

Model Number	MCO-170AIC-PK MCO-170AICUV-PK	MCO-170AICL-PE MCO-170AICUVL-PE MCO-170AICUVL-PA	MCO-170AICUVHL-PE MCO-170AICUVHL-PA	MCO-230AIC-PK MCO-230AICUV-PK	MCO-230AICL-PE MCO-230AICUVL-PE MCO-230AICUVL-PA
External dimensions (W x D x H)*1	620 x 730 x 905			770 x 730 x 905	
Internal dimensions (W x D x H)	490 x 523 x 665			643 x 523 x 700	
Volume	165			230	
Net weight	80			90	
Performance					
Temperature control range	°C ambient temperature +5 to 50*2 (AT 5°C to 35°C)				
Temperature control uniformity*3	°C ±0.25*4				
CO ₂ control range and deviation*3	% 0 to 20 / ±0.15				
CO ₂ sensor platform	Ceramic based, single beam infrared sensor, with dual wavelength measurement for continuous auto-zero calibration				
CO ₂ sampling, patent pending	No moving parts; airflow passes over in/out ports to sustain continuous sampling				
CO ₂ calibration	Automatic, continuous zero reference calibration. Optional STD gas auto calibration				
Airflow	Gentle vertical airflow, continuous with inner door closed				
Interior humidity	% RH 95 ±5 at 37°C by natural evaporation with humidifying pan				
Control, monitoring, alarm					
Temperature and CO ₂ control	P.I.D. control system setpoint resolution 0.1°C, 0.1%				
Data acquisition	Automatic log function of temperature, CO ₂ , Door opening/closing, Alarm and CSV file output				
Communication	Remote alarm contacts standard. Optional 4-20mA connection. Optional with RS-232C/RS-485/LAN data ports*5				
Construction					
Display	Touch Panel (WVGA full color LCD)				
USB data logging	Standard				
Exterior cabinet and door	Galvanized steel with baked-on finish				
Interior and shelves	Copper-enriched stainless steel				
Inner door	Tempered glass				
Outer door	Field-reversible, Heated				
Shelves	qty	4 x standard (Maximum 10)		4 x standard (Maximum 10)	
Shelf dimensions (W x D x H)	mm	475 x 450 x 12, maximum load 7 kg/shelf		628 x 450 x 12, maximum load 7 kg/shelf	
Insulation	Styrene Acrylonitrile Copolymer				
Access port	Diameter 30mm port with non-VOC silicone stoppers (1 on back side)				
Leveling feet	4, Adjustable				
Energy and CO₂ utilities					
Maximum power consumption	W	380		440	
Maximum heat dissipation	kJ/h	1,070		1,250	
CO ₂ gas connection	mm	4 to 6 ID tubing			
CO ₂ gas pressure	0.03 MPa (G) — 0.1 MPa (G) [0.3 kgf/cm ² (G) — 1 kgf/cm ² (G), 4.4 psi (G) — 14.5 psi (G)] from two stage CO ₂ regulator				
Electrical					
Power supply	V	220	220-240 (PE) / 110-120 (PA)	220	220-240 (PE) / 110-120 (PA)
Frequency	Hz	60	50 (PE) / 60 (PA)	60	50 (PE) / 60 (PA)
Quality Management System**					
Certification	ISO13485		ISO9001	ISO13485	ISO9001

*1 External dimensions of main cabinet only. See dimension drawings showing handles and other external projections. *2 When set temperature is 37°C, ambient temperature must be 32°C or less. Regardless of ambient temperature, the maximum of temperature control range is always 50°C. *3 Air temperature measured at incubator centre, ambient temperature 23°C, SV 37°C, CO₂: 5%, no load. *4 The measurement condition complies with PHCbi specified measuring method. *5 For the data acquisition system MTR-5000 user only. *6 MCO-170AICL, MCO-170AICUVL, MCO-170AICUVHL, MCO-230AICL and MCO-230AICUVL are for laboratory use. • The optimum performance may not be obtained if the ambient temperature is not above 15°C.

Optional Accessories

Model Number	MCO-170AIC MCO-170AICL	MCO-170AICUV MCO-170AICUVL	MCO-170AICUVHL	MCO-230AIC MCO-230AICL	MCO-230AICUV*7 MCO-230AICUVL
UV System Set	MCO-170UVS-PE MCO-170UVS-PA	Standard		MCO-170UVS-PE MCO-170UVS-PA	Standard
H ₂ O ₂ Decontamination Control Board	MCO-170HB-PE/-PA		Standard	MCO-170HB-PE/-PA	
Electric Lock	MCO-170EL-PW			MCO-170EL-PW	
H ₂ O ₂ Generator			MCO-HP-PW		
H ₂ O ₂ Reagent			MCO-H2O2-PV		
Gas Regulator			MCO-010R-PW		
Gas Auto Changer			MCO-21GC-PW		
CO ₂ Gas Auto Changer			MCO-21GCP-PW		
STD Gas Auto Calibration Kit			MCO-5GP-PW		
Tray (same as that of standard accessory)	MCO-170ST-PW			MCO-230ST-PW	
Half Tray	MCO-25ST-PW			MCO-35ST-PW	
Reinforced Additional Tray [inCu-saFe®]	MCO-170RT-PW			MCO-230RT-PW	
Double-stacking Bracket	MCO-170PS-PW			MCO-170PS-PW	
Stacking Plate	MCO-230SB-PW			MCO-230SB-PW	
Roller Base	MCO-170RB-PW			MCO-230RB-PW	
Small Door	MCO-170ID-PW			-	
Optional Communication Systems					
Interface Board*8; for LAN			MTR-L03-PW		
Interface Board*8; for RS-232C/RS-485			MTR-480-PW		
Interface Board (4-20mA)			MCO-420MA-PW		

*7 Attaching the optional MCO-170HB and MCO-170EL to MCO-230AICUV will add the H₂O₂ decontamination function.
*8 For the data acquisition system MTR-5000 user only.

Double-stacking matching table

Accessories needed for stacking 2 units	Upper unit		
	MCO-230AIC	MCO-170PS-PW	MCO-170AIC (M) MCO-170AICD
Lower unit	MCO-230AIC	MCO-170PS-PW	MCO-230SB-PW
	MCO-170AIC (M)	-	MCO-170PS-PW
	MCO-170AICD	-	MCO-170PS-PW
	MCO-20AIC	MCO-230SB-PW	MCO-230SB-PW
	MCO-5AC (M)	-	-
MCO-50AIC (M)	-	-	

Field-reversible Door (select left/right opening)

• Appearance and specifications are subject to change without notice.
Caution: PHC Corporation guarantees this product under certain warranty conditions. However, please note that PHC Corporation shall not be responsible for any loss or damage to the contents of the product.



Enhance your cell growth with an intelligent CO₂ incubator designed for precise temperature and CO₂ control, efficient cleaning and rapid decontamination.



*1 Standard for Model No. including UV. *2 Standard for MCO-170AICUVHL/MCO-170AICUVHL

<p>Preservation Equipment, Experimental Environment Equipment, Dispensary Equipment, Culturing Equipment and Drying & Sterilising Equipment for General Laboratory use</p> <p>The management of the design, development, production and servicing of the above.</p>	<p>Freezers, Refrigerators, Incubators, and Drying and Sterilising Equipment for Medical use</p> <p>The management of the design, development, production and distribution of the above.</p>	<p>PHC Corporation Biomedical Division is certified for: Environmental management system: ISO14001</p>
---	--	--

Next Generation Incubators for Optimum Cell Culture

PHCbi's CO₂ incubators with touchscreen control panels deliver superior usability, rapid cleaning, and effortless maintenance while keeping the tradition of outstanding environmental stability and precise performance.

Grow results, not bacteria!

MCO-170AIC/MCO-230AIC Incubators

Optimized for high-value samples including hard-to-grow and contamination-sensitive media/reagents.

Applications:

- Stem cell research
- Autologous tissue regeneration
- Genomic and proteomic expression
- Esoteric plant and amphibian cell cultures
- Hyper-sensitive and transgenic cell cultures
- Low volume media microplate work

Easy Use & Easy Maintenance

Integrated Tray Catches minimize cleaning time while LCD Panel enhances operation

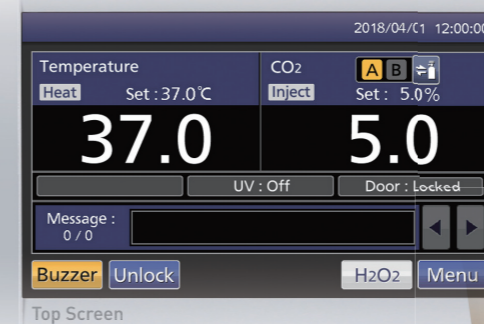

Responds to gloved finger action.

LCD Touch Panel Controller

A WVGA color LCD touch panel delivers full control over different protocols. Control can be performed with gloved fingers as the controller is equipped with a resistive touch-screen.

USB Memory Data Transfer

Standard USB port provides convenient log data transfer to a USB memory stick and to a PC. Data log period is 1.5 months using 2-minute intervals.



Log screen example (CO₂ level)

Note: It is impossible to use a USB memory device which is password-protected.

Security

Automatic door lock (Electric Lock) can be set on the MCO-170AICUVH (standard equipped) and other models equipped with the optional Electric Lock (MCO-170EL).

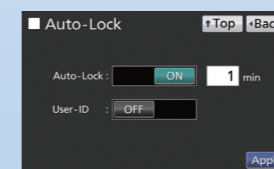
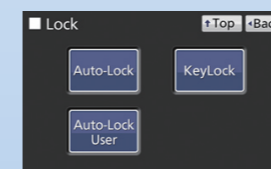

The Auto-Lock set up screen

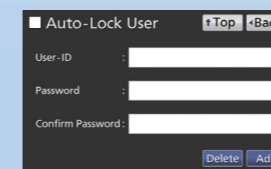

User-ID setting screen



Integrated Tray Catches

Tray catches are integral parts of the chamber, opening up more space for trays, allowing the incubator to accommodate more culture containers. (Comparison with MCO-20AIC/MCO-19AIC)



MCO-170AIC's/MCO-230AIC's interior components

MCO-170AIC's Tray
Internal dimensions
475(W) x 450(D)mm

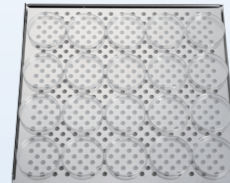

Up to 24 ø100 mm dishes (92 mm) can be arrayed (5 wide x 4 deep)
*In-house comparison
16 dishes (MCO-19AIC)
→ **20 dishes** (MCO-170AIC)



MCO-170AIC's/MCO-230AIC's tray catches (integral part of the chamber)

MCO-230AIC's Tray
Internal dimensions
620(W) x 450(D)mm

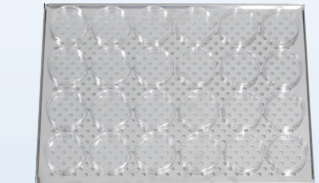

Up to 24 ø100 mm dishes (92 mm) can be arrayed (6 wide x 4 deep)
*In-house comparison
20 dishes (MCO-20AIC)
→ **24 dishes** (MCO-230AIC)

Optimal Humidity Control

Stable humidity control not influenced by environmental conditions and frequent incubator door openings.



Japan and US patents pending

- Control Panel with single-user Key Lock (All models include as standard equipment.)
- Addition of user ID function for better traceability (able to register up to 99 user-IDs and passwords) (MCO-170AICUVH includes it as standard. Or optional MCO-170EL to be installed for other models.)

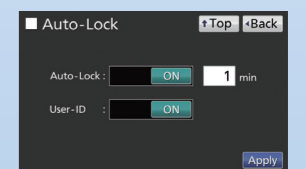
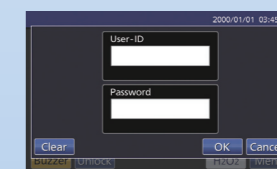

- Multiple detailed activity logs exported to individual CSV files.
(*User Access log downloaded for MCO-170AICUVH as standard. Or optional MCO-170EL to be installed for other models.)

Date	Time	Temp	CO2	Door	Unlock_User
2015/3/16	11:13:38	37	0	Door Open	
2015/3/16	11:13:42	37	0	Door Close	
2015/3/16	11:32:10	37	0	Door Open	Aa001
2015/3/16	11:32:25	37	0	Door Close	
2015/3/16	13:40:56	37	0	Door Open	Bb002
2015/3/16	13:41:09	36.9	0	Door Close	
2015/3/16	13:50:01	36.9	0	Door Open	Cc003
2015/3/16	13:51:19	35.6	0	Door Close	
2015/3/16	15:27:40	37	0	Door Open	Aa001

User Access log*

inCu saFe[®] Construction for Germicidal Protection

- PHCbi offers the exclusive use of inCu-saFe[®] copper-enriched stainless steel alloy interior surfaces within a technical design created to eliminate contamination sources and to mitigate the effect of airborne contaminants introduced through normal use.
- Chart summarizes test results with four strains of mycoplasma. Results demonstrate how PHCbi inCu-saFe[®] copper-enriched stainless steel alloy offers germicidal properties of conventional C1100 copper while maintaining both corrosion-proof and discoloration-resistant properties of conventional stainless steel 304.

Mycoplasma Stain	Positive Control	Conventional Stainless Steel 304	PHCbi inCu-saFe [®]	Conventional Copper C1100
Mycoplasma fermentans PG18	YES	YES	NO	NO
Mycoplasma orale CH19299				
Mycoplasma arginini G230				
Mycoplasma hominis PG21				

"YES" mycoplasma strains grew on the material.
"NO" no mycoplasma strain grew on the material.

Accurate Temperature Control

- The patented Direct Heat and Air Jacket conditioning system precisely regulates temperature through three independent heating zones under microprocessor PID* control. Uniform temperatures are further enhanced by gentle fan circulation.



*Proportional Integral Derivative

- The main heater provides precise temperature control.
- The bottom heater warms the distilled water and controls chamber humidity.
- The outer door heater prevents condensation on the inner door and facilitates quick temperature recovery after door openings.

Direct Heat and Air Jacket Conditioning System

- To avoid cell culture desiccation, the MCO-170AIC/MCO-230AIC maintains up to 90% RH at 37°C.
- Humidification is achieved by reliable natural evaporation and forced-air circulation.

Dimensions

Unit: mm

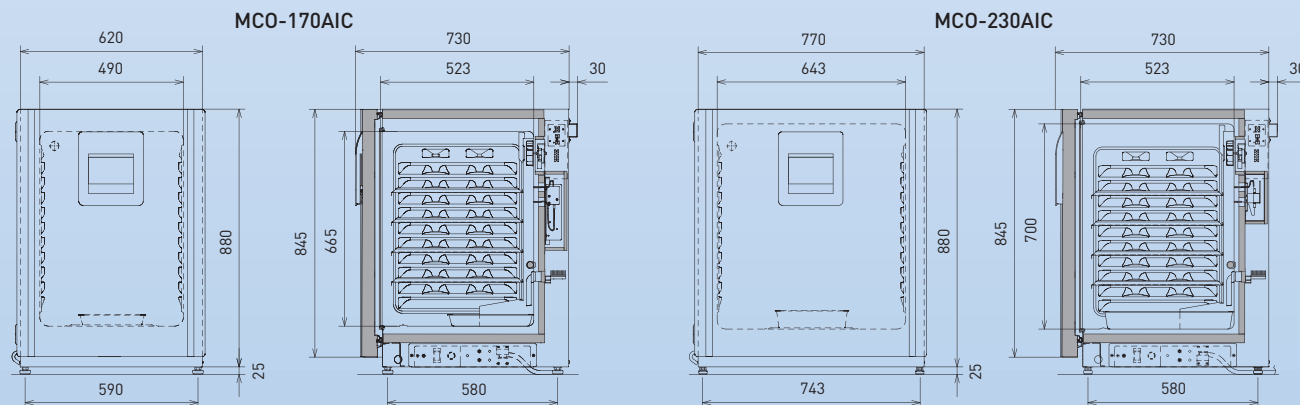

Precise CO₂ Control

- PHCbi proprietary single beam dual detector infrared CO₂ system offers unprecedented control accuracy and stability by simultaneously measuring two wavelengths for continuous zero calibration.
- Benefits include ultra-fast recovery without overshoot and accurate CO₂ averages during periods of frequent incubator access with multiple door openings.
- An optional STD Gas Auto Calibration Kit is available.

SafeCell UV Decontamination

- SafeCell UV includes a programmable ultraviolet lamp, isolated from cell cultures, that decontaminates conditioned air and humidity reservoir water to prevent contamination without affecting cell cultures in vitro.
- Contaminants trapped within the humidifying pan at the base of the plenum are destroyed by high intensity, ozone-free ultraviolet light.
- Decontaminated, humidified air is released from the lower plenum for vertical convection through and around the perforated shelves. Interior air motion is suspended when the door is opened, minimizing movement of room air contaminants into the chamber. The unique air duct system also improves temperature recovery characteristics.

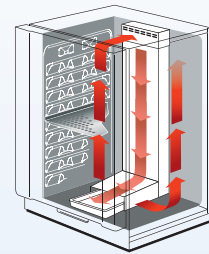

Airflow and water pan decontamination using a UV system

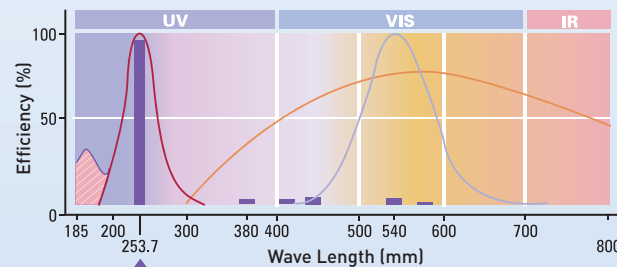

Use of the MCO-170AICUVH/MCO-170AICUV/MCO-170AICUVL/MCO-230AICUV/MCO-230AICUVL ultraviolet lamp is a highly effective ozone-free contamination control technique.

PHCbi Lamp Ozone Release Germicidal Effect Sunlight

The SafeCell UV lamp cycle is factory set for normal use, and can be re-programmed as desired by entering parameters through the central microprocessor control panel. Program parameters for the H₂O₂ decontamination cycle are non-adjustable for operator safety.

Rapid, Effective and Safe H₂O₂ Decontamination Cycle

- Industry-first PHCbi unique high-speed decontamination system utilizing vaporized H₂O₂ offers time-saving and documented chamber decontamination with complete safety.
- Full decontamination process takes less than three hours, saving valuable time. For example, if the decontamination cycle is started at 9 am, the unit will be ready for use in the afternoon.
- All interior components are decontaminated in situ. No need for time-consuming removal and autoclaving.
- No high heat emission. No sensor removal necessary.

- After decontamination H₂O₂ vapor is decomposed to harmless water and oxygen by UV light.
- Outer door is locked automatically by the electric interlock system during the decontamination cycle to ensure operator safety.
- Unlike high-heat decontamination incubators, PHCbi's unique H₂O₂ decontamination cycle does not emit high heat. Therefore, when two MCO-170AIC/MCO-230AIC units are stacked, one incubator can be decontaminated without affecting the temperature of the other.

H₂O₂ decontamination process (example)

Preparation Approx. 10 minutes

STEP 1 Remove all interior components >> Clean the chamber >> Reposition interior components to positions specified for in situ decontamination

STEP 2 Set up the H₂O₂ Generator (MCO-HP)*

*H₂O₂ Generator is an optional accessory. See back page.
*Decontamination requires PHCbi H₂O₂ Reagent (Sold separately).

STEP 3 Only two manual control steps needed

Depress H₂O₂ button | Graphic user manual | System check | Press OK button to start decontamination

Decontamination Approx. 135 minutes

Warm-up | H₂O₂ vapor generation | UV reduction | Decontamination complete

STEP 4 Ventilation >> Wipe out the chamber >> Reposition interior components to normal positions

Finish Approx. 10 minutes

Start Decontamination starting at 9 am allows cultures to be started or resumed by the afternoon.

Chamber conditions during decontamination

Start of H₂O₂ solution vaporization
H₂O₂ solution in the H₂O₂ Generator (MCO-HP) is sprayed into the chamber by the ultrasonic transducer.

H₂O₂ fills up chamber
H₂O₂ mist is quickly gasified to thoroughly fill up the chamber.

UV radiation for H₂O₂ reduction
• UV lamp turns on.
• H₂O₂ gas is reduced to water and oxygen.

*Above H₂O₂ vaporization photos are concept images only.

*Above decontamination process is performed with standard interior items. Additional shelves and dishes may reduce decontamination effectiveness.

*Decontamination times shown above are for indication only. Actual process time may differ depending on chamber cleaning time and set-up time.

Time comparison between the H₂O₂ decontamination process and sterilization at above 180°C

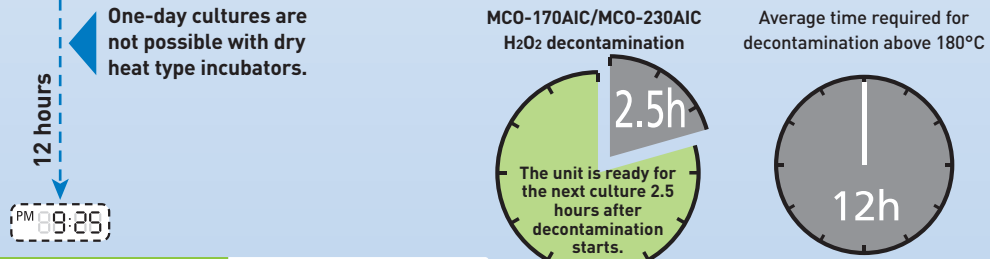

Performance Data MCO-170AIC / MCO-230AIC

*Internal research as of November 2013

